

Lagerprogramm T 2,5

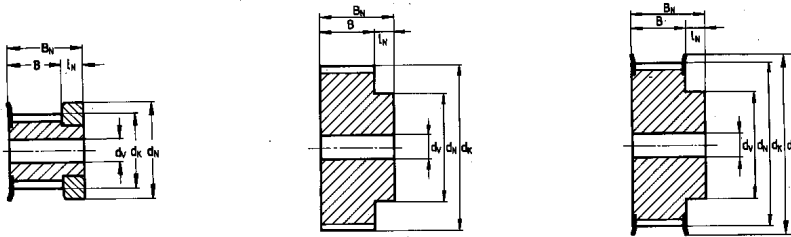

Ausführung 1

Ausführung - 0

Ausführung - 2

Bestellbezeichnung

Lagerscheibe	LS	20	T2,5/	48	-	0	Nabe	26 x 6
Gesamtbreite								
Teilung								
Zähnezahl								
Anzahl Bordscheiben								
Nabendurchmesser								
Nabenlänge								

Bestellbezeichnung	d H7 ohne Nut mm	dk	Verzahnte Breite B	Bordscheibe dB mm	Werkstoff Zahnscheibe	Type	EUR/€ Stück
--------------------	------------------	----	--------------------	-------------------	-----------------------	------	-------------

T 2,5	Bestellbezeichnung	d H7 ohne Nut mm	dk	Verzahnte Breite B	Bordscheibe dB mm	Werkstoff Zahnscheibe	Type	EUR/€ Stück
Riemenbreite b=6 mm	16T2.5/10-2Nb10x6	d=3	7,45	10 mm	10x5x1	AlCuMg1	1	6,54 €
	16T2.5/12-2Nb12x6	d=3	9,04	10 mm	12x6x1	AlCuMg1	1	6,60 €
	16T2.5/14-2Nb14x6	d=3	10,63	10 mm	14x8x1	AlCuMg1	1	6,66 €
	16T2.5/15-2Nb15x6	d=3	11,43	10 mm	15x9x1	AlCuMg1	1	6,72 €
	16T2.5/16-2Nb16x6	d=4	12,22	10 mm	16x1x1	AlCuMg1	1	6,77 €
	16T2.5/18-2Nb10x6	d=4	13,81	10 mm	17x11x1	AlCuMg1	2	6,85 €
	16T2.5/19-2Nb10x6	d=4	14,61	10 mm	18x12x1	AlCuMg1	2	7,10 €
	16T2.5/20-2Nb12x6	d=4	15,41	10 mm	19x13x1	AlCuMg1	2	7,36 €
	16T2.5/24-2Nb14x6	d=4	18,59	10 mm	22x15x1	AlCuMg1	2	7,48 €
	16T2.5/25-2Nb14x6	d=4	19,38	10 mm	23x15x1	AlCuMg1	2	7,61 €
	16T2.5/30-2Nb16x6	d=6	23,36	10 mm	28x20x1	AlCuMg1	2	7,94 €
	16T2.5/32-2Nb16x6	d=6	24,95	10 mm	28x20x1	AlCuMg1	2	8,11 €
	16T2.5/36-2Nb20x6	d=6	28,14	10 mm	32x22x1	AlCuMg1	2	8,17 €
	16T2.5/40-2Nb22x6	d=6	31,32	10 mm	35x25x1	AlCuMg1	2	8,49 €
	16T2.5/48-0Nb26x6	d=6	37,69	10 mm	0	AlCuMg1	0	8,95 €
	16T2.5/48-2Nb26x6	d=6	37,69	10 mm	42x30x1	AlCuMg1	2	14,29 €
16T2.5/60-0Nb34x6	d=8	47,24	10 mm	0	AlCuMg1	0	9,44 €	
16T2.5/60-2Nb34x6	d=8	47,24	10 mm	52x40x1	AlCuMg1	2	15,17 €	

T 2,5	Bestellbezeichnung	d H7 ohne Nut mm	dk	Verzahnte Breite B	Bordscheibe dB mm	Werkstoff Zahnscheibe	Type	EUR/€ Stück
Riemenbreite b=10 mm	20T2.5/10-2Nb10x6	d=3	7,45	14 mm	10x5x1	AlCuMg1	1	7,86 €
	20T2.5/12-2Nb12x6	d=3	9,04	14 mm	12x6x1	AlCuMg1	1	8,05 €
	20T2.5/14-2Nb14x6	d=3	10,63	14 mm	14x8x1	AlCuMg1	1	8,24 €
	20T2.5/15-2Nb15x6	d=3	11,43	14 mm	15x9x1	AlCuMg1	1	8,43 €
	20T2.5/16-2Nb16x6	d=4	12,22	14 mm	16x1x1	AlCuMg1	1	8,57 €
	20T2.5/18-2Nb10x6	d=4	13,81	14 mm	17x11x1	AlCuMg1	2	8,76 €
	20T2.5/19-2Nb10x6	d=4	14,61	14 mm	18x12x1	AlCuMg1	2	8,87 €
	20T2.5/20-2Nb12x6	d=4	15,41	14 mm	19x13x1	AlCuMg1	2	8,93 €
	20T2.5/24-2Nb14x6	d=4	18,59	14 mm	22x15x1	AlCuMg1	2	9,08 €
	20T2.5/25-2Nb14x6	d=4	19,38	14 mm	23x15x1	AlCuMg1	2	9,25 €
	20T2.5/30-2Nb16x6	d=6	23,36	14 mm	28x20x1	AlCuMg1	2	9,71 €
	20T2.5/32-2Nb16x6	d=6	24,95	14 mm	28x20x1	AlCuMg1	2	10,15 €
	20T2.5/36-2Nb20x6	d=6	28,14	14 mm	32x22x1	AlCuMg1	2	10,27 €
	20T2.5/40-2Nb22x6	d=6	31,32	14 mm	35x25x1	AlCuMg1	2	11,22 €
	20T2.5/48-0Nb26x6	d=6	37,69	14 mm	0	AlCuMg1	0	11,47 €
	20T2.5/48-2Nb26x6	d=6	37,69	14 mm	42x30x1	AlCuMg1	2	14,90 €
20T2.5/60-0Nb34x6	d=8	47,24	14 mm	0	AlCuMg1	0	12,04 €	
20T2.5/60-2Nb34x6	d=8	47,24	14 mm	52x40x1	AlCuMg1	2	17,76 €	

Lagerprogramm T 5

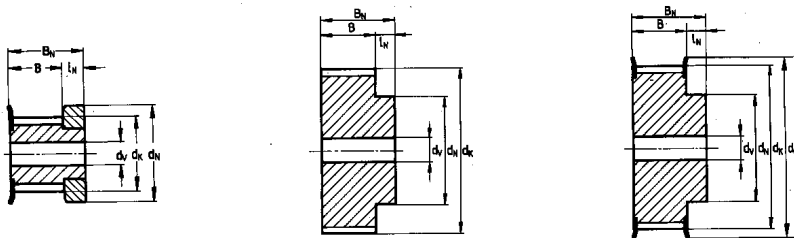

Ausführung 1

Ausführung - 0

Ausführung - 2

Bestellbezeichnung

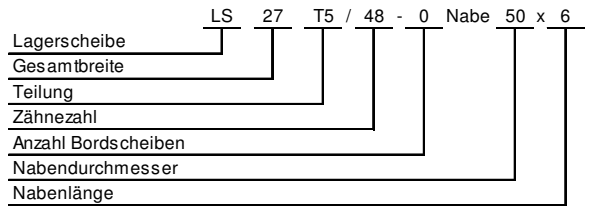

Bestellbezeichnung	d H7 ohne Nut mm	dk	Verzahnte Breite B	Bordscheibe dB mm	Werkstoff Zahnscheibe	Type	EUR/€ Stück
--------------------	------------------	----	--------------------	-------------------	-----------------------	------	-------------

T 5	Riemenbreite b=10 mm	Bestellbezeichnung	d H7 ohne Nut mm	dk	Verzahnte Breite B	Bordscheibe dB mm	Werkstoff Zahnscheibe	Type	EUR/€ Stück
		21T5/10-2Nb8x6	d=4	15,05	10mm	18x12x1	AlCuMg1	2	5,03 €
21T5/12-2Nb12x6	d=4	18,25	10mm	23x15x1	AlCuMg1	2	5,29 €		
21T5/14-2Nb14x6	d=6	21,45	10mm	26x18x1	AlCuMg1	2	5,46 €		
21T5/15-2Nb16x6	d=6	23,05	10mm	28x20x1	AlCuMg1	2	5,55 €		
21T5/16-2Nb18x6	d=6	24,60	10mm	30x22x1	AlCuMg1	2	5,72 €		
21T5/18-2Nb20x6	d=6	27,80	10mm	34x24x1	AlCuMg1	2	5,90 €		
21T5/19-2Nb22x6	d=6	29,40	10mm	35x25x1	AlCuMg1	2	6,24 €		
21T5/20-2Nb24x6	d=6	31,00	10mm	36x26x1	AlCuMg1	2	6,42 €		
21T5/24-2Nb26x6	d=6	37,35	10mm	42x30x1	AlCuMg1	2	6,76 €		
21T5/25-2Nb26x6	d=6	38,95	10mm	43x31x1	AlCuMg1	2	7,11 €		
21T5/27-2Nb30x6	d=8	42,15	10mm	47x35x1	AlCuMg1	2	7,67 €		
21T5/30-2Nb34x6	d=8	46,90	10mm	52x40x1	AlCuMg1	2	7,89 €		
21T5/32-2Nb38x6	d=8	50,10	10mm	55x43x1	AlCuMg1	2	8,15 €		
21T5/36-2Nb38x6	d=8	56,45	10mm	61x49x1	AlCuMg1	2	8,84 €		
21T5/40-2Nb40x6	d=8	62,85	10mm	68x54x1	AlCuMg1	2	9,80 €		
21T5/48-0Nb50x6	d=8	75,55	10mm	0	AlCuMg1	0	10,19 €		
21T5/48-2Nb50x6	d=9	75,55	10mm	80x66x1	AlCuMg1	2	16,64 €		
21T5/60-0Nb65x6	d=8	94,65	10mm	0	AlCuMg1	0	11,97 €		
21T5/60-2Nb65x6	d=9	94,65	10mm	99x85x1	AlCuMg1	2	18,76 €		

T 5	Riemenbreite b=16 mm	Bestellbezeichnung	d H7 ohne Nut mm	dk	Verzahnte Breite B	Bordscheibe dB mm	Werkstoff Zahnscheibe	Type	EUR/€ Stück
		27T5/10-2Nb8x6	d=4	15,05	16mm	18x12x1	AlCuMg1	2	5,55 €
27T5/12-2Nb12x6	d=4	18,25	16mm	23x15x1	AlCuMg1	2	5,72 €		
27T5/14-2Nb14x6	d=6	21,45	16mm	26x18x1	AlCuMg1	2	5,94 €		
27T5/15-2Nb16x6	d=6	23,05	16mm	28x20x1	AlCuMg1	2	6,16 €		
27T5/16-2Nb18x6	d=6	24,60	16mm	30x22x1	AlCuMg1	2	6,42 €		
27T5/18-2Nb20x6	d=6	27,80	16mm	34x24x1	AlCuMg1	2	6,72 €		
27T5/19-2Nb22x6	d=6	29,40	16mm	35x25x1	AlCuMg1	2	7,15 €		
27T5/20-2Nb24x6	d=6	31,00	16mm	36x26x1	AlCuMg1	2	7,20 €		
27T5/24-2Nb26x6	d=6	37,35	16mm	42x30x1	AlCuMg1	2	7,67 €		
27T5/25-2Nb26x6	d=6	38,95	16mm	43x31x1	AlCuMg1	2	7,89 €		
27T5/27-2Nb30x6	d=8	42,15	16mm	47x35x1	AlCuMg1	2	8,52 €		
27T5/30-2Nb34x6	d=8	46,90	16mm	52x40x1	AlCuMg1	2	8,67 €		
27T5/32-2Nb38x6	d=8	50,10	16mm	55x43x1	AlCuMg1	2	9,06 €		
27T5/36-2Nb38x6	d=8	56,45	16mm	61x49x1	AlCuMg1	2	9,54 €		
27T5/40-2Nb40x6	d=8	62,85	16mm	68x54x1	AlCuMg1	2	10,10 €		
27T5/48-0Nb50x6	d=8	75,55	16mm	0	AlCuMg1	0	10,67 €		
27T5/48-2Nb50x6	d=8	75,55	16mm	80x66x1	AlCuMg1	2	17,11 €		
27T5/60-0Nb65x6	d=8	94,65	16mm	0	AlCuMg1	0	12,70 €		
27T5/60-2Nb65x6	d=8	94,65	16mm	99x85x1	AlCuMg1	2	19,49 €		

Lagerprogramm T 5

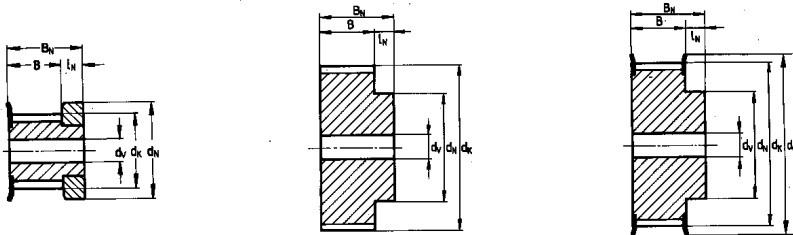

Ausführung 1

Ausführung - 0

Ausführung - 2

Bestellbezeichnung

Lagerscheibe	LS	36	T5 / 48	- 0	Nabe	50 x 6
Gesamtbreite						
Teilung						
Zähnezahl						
Anzahl Bordscheiben						
Nabendurchmesser						
Nabenlänge						

Bestellbezeichnung	d H7 ohne Nut mm	dk	Verzahnte Breite B	Bordscheibe dB mm	Werkstoff Zahnscheibe	Type	EUR/€ Stück
--------------------	------------------	----	--------------------	-------------------	-----------------------	------	-------------

Bestellbezeichnung	d H7 ohne Nut mm	dk	Verzahnte Breite B	Bordscheibe dB mm	Werkstoff Zahnscheibe	Type	EUR/€ Stück	
T 5 Riemenbreite b=25 mm	36T5/10-2Nb8x6	d=4	15,05	25mm	18x12x1	AlCuMg1	2	6,63 €
	36T5/12-2Nb12x6	d=4	18,25	25mm	23x15x1	AlCuMg1	2	6,94 €
	36T5/14-2Nb14x6	d=6	21,45	25mm	26x18x1	AlCuMg1	2	7,15 €
	36T5/15-2Nb16x6	d=6	23,05	25mm	28x20x1	AlCuMg1	2	7,28 €
	36T5/16-2Nb18x6	d=6	24,60	25mm	30x22x1	AlCuMg1	2	7,67 €
	36T5/18-2Nb20x6	d=6	27,80	25mm	34x24x1	AlCuMg1	2	7,80 €
	36T5/19-2Nb22x6	d=6	29,40	25mm	35x25x1	AlCuMg1	2	8,15 €
	36T5/20-2Nb24x6	d=6	31,00	25mm	36x26x1	AlCuMg1	2	8,50 €
	36T5/24-2Nb26x6	d=6	37,35	25mm	42x30x1	AlCuMg1	2	8,76 €
	36T5/25-2Nb26x6	d=6	38,95	25mm	43x31x1	AlCuMg1	2	9,19 €
	36T5/27-2Nb30x6	d=8	42,15	25mm	47x35x1	AlCuMg1	2	9,71 €
	36T5/30-2Nb34x6	d=8	46,90	25mm	52x40x1	AlCuMg1	2	10,06 €
	36T5/32-2Nb38x6	d=8	50,10	25mm	55x43x1	AlCuMg1	2	10,41 €
	36T5/36-2Nb38x6	d=8	56,45	25mm	61x49x1	AlCuMg1	2	12,31 €
	36T5/40-2Nb40x6	d=8	62,85	25mm	68x54x1	AlCuMg1	2	12,92 €
	36T5/48-0Nb50x6	d=8	75,55	25mm	80x66x1	AlCuMg1	0	13,87 €
	36T5/48-2Nb50x6	d=9	75,55	25mm	156x142x1,5	AlCuMg1	2	20,32 €
	36T5/60-0Nb65x6	d=8	94,65	25mm	0	AlCuMg1	0	16,82 €
36T5/60-2Nb65x6	d=9	94,65	25mm	99x85x1	AlCuMg1	2	23,61 €	

Lagerprogramm T 10

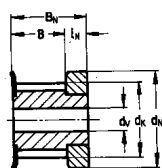

Ausführung 1

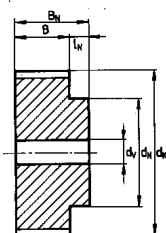

Ausführung - 0

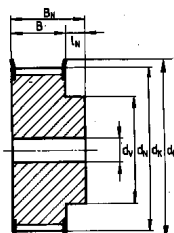

Ausführung - 2

Bestellbezeichnung

Lagerscheibe	LS	40	T10 / 60	- 0	Nabe 110 x 10
Gesamtbreite					
Teilung					
Zähnezahl					
Anzahl Bordscheiben					
Nabendurchmesser					
Nabenlänge					

Bestellbezeichnung	d H7 ohne Nut mm	dk	Verzahnte Breite B	Bordscheibe dB mm	Werkstoff Zahnscheibe	Type	EUR/€ Stück
--------------------	------------------	----	--------------------	-------------------	-----------------------	------	-------------

T 10 Riemenbreite b=16 mm	31T10/12-2Nb28x10	d=6	36,35	16mm	42x30x1	AlCuMg1	2	7,01 €
	31T10/14-2Nb32x10	d=8	42,70	16mm	48x36x1	AlCuMg1	2	7,67 €
	31T10/15-2Nb32x10	d=8	45,90	16mm	52x40x1	AlCuMg1	2	8,00 €
	31T10/16-2Nb35x10	d=8	49,10	16mm	55x43x1	AlCuMg1	2	8,02 €
	31T10/18-2Nb40x10	d=10	55,45	16mm	61x49x1	AlCuMg1	2	9,58 €
	31T10/19-2Nb44x10	d=10	58,65	16mm	64x52x1	AlCuMg1	2	10,15 €
	31T10/20-2Nb46x10	d=12	61,80	16mm	68x54x1	AlCuMg1	2	10,84 €
	31T10/24-2Nb58x10	d=12	74,55	16mm	80x66x1	AlCuMg1	2	11,79 €
	31T10/25-2Nb60x10	d=12	77,75	16mm	84x70x1	AlCuMg1	2	12,66 €
	31T10/27-2Nb60x10	d=12	84,10	16mm	90x76x1	AlCuMg1	2	14,48 €
	31T10/30-2Nb60x10	d=12	93,65	16mm	99x85x1	AlCuMg1	2	16,00 €
	31T10/32-2Nb65x10	d=12	100,00	16mm	106x92x1	AlCuMg1	2	18,56 €
	31T10/36-2Nb70x10	d=16	112,75	16mm	118x104x1,5	AlCuMg1	2	21,33 €
	31T10/40-2Nb80x10	d=16	125,45	16mm	131x117x1,5	AlCuMg1	2	24,70 €
	31T10/48-0Nb95x10	d=16	150,95	16mm	0	AlCuMg1	0	28,92 €
	31T10/48-2Nb95x10	d=17	150,95	16mm	156x142x1,5	AlCuMg1	2	42,48 €
31T10/60-0Nb110x10	d=16	189,15	16mm	0	AlCuMg1	0	37,98 €	
31T10/60-2Nb110x10	d=17	189,15	16mm	196x176x1,5	AlCuMg1	2	53,24 €	

T 10 Riemenbreite b=25 mm	40T10/12-2Nb28x10	d=6	36,35	25mm	42x30x1	AlCuMg1	2	8,67 €
	40T10/14-2Nb32x10	d=8	42,70	25mm	48x36x1	AlCuMg1	2	9,54 €
	40T10/15-2Nb32x10	d=8	45,90	25mm	52x40x1	AlCuMg1	2	10,28 €
	40T10/16-2Nb35x10	d=8	49,10	25mm	55x43x1	AlCuMg1	2	10,84 €
	40T10/18-2Nb40x10	d=10	55,45	25mm	61x49x1	AlCuMg1	2	11,62 €
	40T10/19-2Nb44x10	d=10	58,65	25mm	64x52x1	AlCuMg1	2	12,14 €
	40T10/20-2Nb46x10	d=12	61,80	25mm	68x54x1	AlCuMg1	2	12,92 €
	40T10/24-2Nb58x10	d=12	74,55	25mm	80x66x1	AlCuMg1	2	14,44 €
	40T10/25-2Nb60x10	d=12	77,75	25mm	84x70x1	AlCuMg1	2	15,09 €
	40T10/27-2Nb60x10	d=12	84,10	25mm	90x76x1	AlCuMg1	2	16,65 €
	40T10/30-2Nb60x10	d=12	93,65	25mm	99x85x1	AlCuMg1	2	18,21 €
	40T10/32-2Nb65x10	d=12	100,00	25mm	106x92x1	AlCuMg1	2	20,64 €
	40T10/36-2Nb70x10	d=16	112,75	25mm	118x104x1,5	AlCuMg1	2	23,85 €
	40T10/40-2Nb80x10	d=16	125,45	25mm	131x117x1,5	AlCuMg1	2	28,70 €
	40T10/48-0Nb95x10	d=16	150,95	25mm	0	AlCuMg1	0	34,34 €
	40T10/48-2Nb95x10	d=17	150,95	25mm	156x142x1,5	AlCuMg1	2	47,91 €
40T10/60-0Nb110x10	d=16	189,15	25mm	0	AlCuMg1	0	46,05 €	
40T10/60-2Nb110x10	d=17	189,15	25mm	196x176x1,5	AlCuMg1	2	61,31 €	

Lagerprogramm T 10

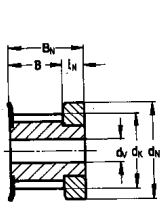

Ausführung 1

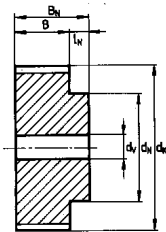

Ausführung - 0

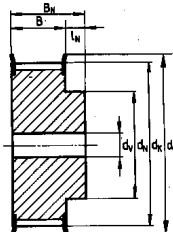

Ausführung - 2

Bestellbezeichnung

Lagerscheibe	LS	66	T10 /	60	-	0	Nabe 110 x 10
Gesamtbreite							
Teilung							
Zähnezahl							
Anzahl Bordscheiben							
Nabendurchmesser							
Nabenlänge							

Bestellbezeichnung	d H7 ohne Nut mm	dk	Verzahnte Breite B	Bordscheibe dB mm	Werkstoff Zahnscheibe	Type	EUR/€ Stück
--------------------	------------------------	----	--------------------------	-------------------------	--------------------------	------	----------------

T 10	50T10/18-2Nb40x10	d=10	55,45	32mm	61x49x1	AlCuMg1	2	14,05 €
Riemenbreite b=32 mm	50T10/19-2Nb44x10	d=10	58,65	32mm	64x52x1	AlCuMg1	2	14,87 €
	50T10/20-2Nb46x10	d=12	61,80	32mm	68x54x1	AlCuMg1	2	16,91 €
	50T10/24-2Nb58x10	d=12	74,55	32mm	80x66x1	AlCuMg1	2	17,21 €
	50T10/25-2Nb60x10	d=12	77,75	32mm	84x70x1	AlCuMg1	2	17,39 €
	50T10/27-2Nb60x10	d=12	84,10	32mm	90x76x1	AlCuMg1	2	18,56 €
	50T10/30-2Nb60x10	d=12	93,65	32mm	99x85x1	AlCuMg1	2	21,55 €
	50T10/32-2Nb65x10	d=12	100,00	32mm	106x92x1	AlCuMg1	2	23,76 €
	50T10/36-2Nb70x10	d=16	112,75	32mm	118x104x1,5	AlCuMg1	2	27,58 €
	50T10/40-2Nb80x10	d=16	125,45	32mm	131x117x1,5	AlCuMg1	2	32,87 €
	50T10/48-0Nb95x10	d=16	150,95	32mm	0	AlCuMg1	0	40,15 €
	50T10/48-2Nb95x10	d=17	150,95		156x142x1,5	AlCuMg1	2	53,71 €
	50T10/60-0Nb110x10	d=16	189,15	32mm	0	AlCuMg1	0	50,73 €
	50T10/60-2Nb110x10	d=16	189,15		196x176x1,5	AlCuMg1	2	65,99 €

T 10	66T10/18-2Nb40x10	d=10	55,45	50mm	61x49x1	AlCuMg1	2	16,39 €
Riemenbreite b=50 mm	66T10/19-2Nb44x10	d=10	58,65	50mm	64x52x1	AlCuMg1	2	18,04 €
	66T10/20-2Nb46x10	d=12	61,80	50mm	68x54x1	AlCuMg1	2	18,50 €
	66T10/24-2Nb58x10	d=12	74,55	50mm	80x66x1	AlCuMg1	2	21,59 €
	66T10/25-2Nb60x10	d=12	77,75	50mm	84x70x1	AlCuMg1	2	21,94 €
	66T10/27-2Nb60x10	d=12	84,10	50mm	90x76x1	AlCuMg1	2	23,67 €
	66T10/30-2Nb60x10	d=12	93,65	50mm	99x85x1	AlCuMg1	2	27,49 €
	66T10/32-2Nb65x10	d=12	100,00	50mm	106x92x1	AlCuMg1	2	31,39 €
	66T10/36-2Nb70x10	d=16	112,75	50mm	118x104x1,5	AlCuMg1	2	36,29 €
	66T10/40-2Nb80x10	d=16	125,45	50mm	131x117x1,5	AlCuMg1	2	43,44 €
	66T10/48-0Nb95x10	d=16	150,95	50mm	0	AlCuMg1	0	47,56 €
	66T10/48-2Nb95x10	d=17	150,95	50mm	156x142x1,5	AlCuMg1	2	61,12 €
	66T10/60-0Nb110x10	d=16	189,15	50mm	0	AlCuMg1	0	64,34 €
	66T10/60-2Nb110x10	d=17	189,15	50mm	196x176x1,5	AlCuMg1	2	79,61 €

Lagerprogramm AT 3

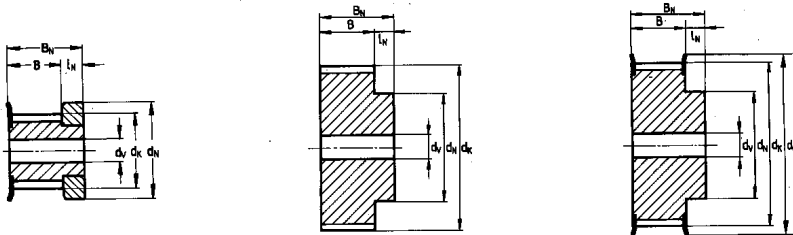

Ausführung 1

Ausführung - 0

Ausführung - 2

Bestellbezeichnung

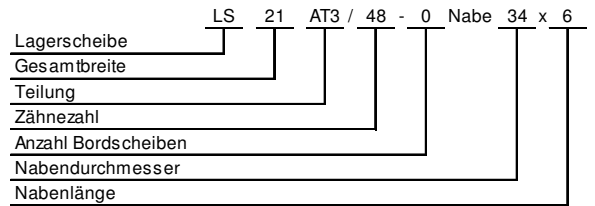

Bestellbezeichnung	d H7 ohne Nut mm	dk	Verzahnte Breite B	Bordscheibe dB mm	Werkstoff Zahnscheibe	Type	EUR/€ Stück
--------------------	------------------------	----	--------------------------	-------------------------	--------------------------	------	----------------

AT 3		d=4	13,91	6mm	17x11x1	AlCuMg1	2	5,16 €
Riemenbreite		d=4	14,87	6mm	18x12x1	AlCuMg1	2	5,50 €
b=6 mm		d=4	16,78	6mm	21x14x1	AlCuMg1	2	5,63 €
		d=4	18,69	6mm	24x16x1	AlCuMg1	2	5,90 €
		d=6	20,60	6mm	26x18x1	AlCuMg1	2	6,33 €
		d=6	22,51	6mm	28x20x1	AlCuMg1	2	6,46 €
		d=6	23,46	6mm	30x22x1	AlCuMg1	2	6,72 €
		d=6	25,37	6mm	30x22x1	AlCuMg1	2	7,38 €
		d=6	28,24	6mm	34x24x1	AlCuMg1	2	7,63 €
		d=6	30,15	6mm	36x26x1	AlCuMg1	2	7,58 €
		d=6	33,97	6mm	40x30x1	AlCuMg1	2	8,67 €
		d=6	37,79	6mm	43x31x1	AlCuMg1	2	9,97 €
		d=6	41,61	6mm	47x35x1	AlCuMg1	0	10,28 €
		d=6	41,61	6mm	47x35x1	AlCuMg1	2	14,52 €
		d=6	42,56	6mm	48x36x1	AlCuMg1	0	10,65 €
		d=6	42,56	6mm	48x36x1	AlCuMg1	2	15,06 €
		d=6	45,43	6mm	0	AlCuMg1	0	11,36 €
		d=6	45,43	6mm	52x40x1	AlCuMg1	2	16,11 €
		d=6	57,00	6mm	0	AlCuMg1	0	12,79 €
		d=6	57,00	6mm	62x50x1	AlCuMg1	2	17,71 €
		d=6	68,34	6mm	0	AlCuMg1	0	14,25 €
		d=6	68,34	6mm	74x60x1	AlCuMg1	2	19,33 €

AT 3		d=4	13,91	10mm	17x11x1	AlCuMg1	2	5,46 €
Riemenbreite		d=4	14,87	10mm	18x12x1	AlCuMg1	2	5,94 €
b=10 mm		d=4	16,78	10mm	21x14x1	AlCuMg1	2	6,11 €
		d=4	18,69	10mm	24x16x1	AlCuMg1	2	6,39 €
		d=6	20,60	10mm	26x18x1	AlCuMg1	2	6,80 €
		d=6	22,51	10mm	28x20x1	AlCuMg1	2	6,99 €
		d=6	23,46	10mm	30x22x1	AlCuMg1	2	7,19 €
		d=6	25,37	10mm	30x22x1	AlCuMg1	2	7,97 €
		d=6	28,24	10mm	34x24x1	AlCuMg1	2	8,72 €
		d=6	30,15	10mm	36x26x1	AlCuMg1	2	9,19 €
		d=6	33,97	10mm	40x30x1	AlCuMg1	2	10,14 €
		d=6	37,79	10mm	43x31x1	AlCuMg1	2	10,89 €
		d=6	41,61	10mm	47x35x1	AlCuMg1	0	11,23 €
		d=4	41,61	10mm	47x35x1	AlCuMg1	2	15,47 €
		d=6	42,56	10mm	48x36x1	AlCuMg1	0	11,48 €
		d=6	42,56	10mm	48x36x1	AlCuMg1	2	15,89 €
		d=6	45,43	10mm	0	AlCuMg1	0	11,97 €
		d=6	45,43	10mm	52x40x1	AlCuMg1	2	16,72 €
		d=6	56,89	10mm	0	AlCuMg1	0	13,79 €
		d=6	56,89	10mm	62x50x1	AlCuMg1	2	18,71 €
		d=6	68,34	10mm	0	AlCuMg1	0	16,04 €
		d=6	68,34	10mm	74x60x1	AlCuMg1	2	21,13 €

Lagerprogramm AT 3

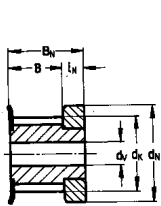

Ausführung 1

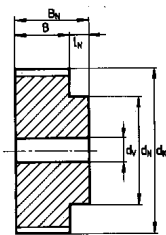

Ausführung - 0

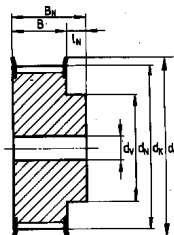

Ausführung - 2

Bestellbezeichnung

Lagerscheibe	LS	28	AT3 /	48	-	0	Nabe	34 x 6
Gesamtbreite								
Teilung								
Zähnezahl								
Anzahl Bordscheiben								
Nabendurchmesser								
Nabenlänge								

Bestellbezeichnung	d H7 ohne Nut mm	dk	Verzahnte Breite B	Bordscheibe dB mm	Werkstoff Zahnscheibe	Type	EUR/€ Stück	
AT 3 Riemenbreite b=16 mm	28AT3/15-2Nb10x6	d=4	13,91	16mm	17x11x1	AlCuMg1	2	5,82 €
	28AT3/16-2Nb10x6	d=4	14,87	16mm	18x12x1	AlCuMg1	2	6,24 €
	28AT3/18-2Nb12x6	d=4	16,78	16mm	21x14x1	AlCuMg1	2	6,50 €
	28AT3/20-2Nb14x6	d=4	18,69	16mm	24x16x1	AlCuMg1	2	6,68 €
	28AT3/22-2Nb14x6	d=6	20,60	16mm	26x18x1	AlCuMg1	2	7,28 €
	28AT3/24-2Nb14x6	d=6	22,51	16mm	28x20x1	AlCuMg1	2	7,41 €
	28AT3/25-2Nb16x6	d=6	23,46	16mm	30x22x1	AlCuMg1	2	7,63 €
	28AT3/27-2Nb16x6	d=6	25,37	16mm	30x22x1	AlCuMg1	2	8,50 €
	28AT3/30-2Nb20x6	d=6	28,24	16mm	34x24x1	AlCuMg1	2	9,63 €
	28AT3/32-2Nb20x6	d=6	30,15	16mm	36x26x1	AlCuMg1	2	10,06 €
	28AT3/36-2Nb22x6	d=6	33,97	16mm	40x30x1	AlCuMg1	2	10,84 €
	28AT3/40-2Nb26x6	d=6	37,79	16mm	43x31x1	AlCuMg1	2	11,67 €
	28AT3/44-0Nb30x6	d=6	41,61	16mm	47x35x1	AlCuMg1	2	11,97 €
	28AT3/44-2Nb30x6	d=6	41,61	16mm	47x35x1	AlCuMg1	2	16,21 €
	28AT3/45-0Nb30x6	d=6	42,56	16mm	48x36x1	AlCuMg1	2	12,23 €
	28AT3/45-2Nb30x6	d=6	42,56	16mm	48x36x1	AlCuMg1	2	16,64 €
	28AT3/48-0Nb34x6	d=6	45,43	16mm	0	AlCuMg1	0	12,57 €
	28AT3/48-2Nb34x6	d=6	45,43	16mm	52x40x1	AlCuMg1	2	17,32 €
	28AT3/60-0Nb38x6	d=6	57,00	16mm	0	AlCuMg1	0	14,57 €
	28AT3/60-2Nb38x6	d=6	57,00	16mm	62x50x1	AlCuMg1	2	19,49 €
28AT3/72-0Nb50x6	d=6	68,45	16mm	0	AlCuMg1	0	17,77 €	
28AT3/72-2Nb50x6	d=6	68,45	16mm	74x60x1	AlCuMg1	2	22,86 €	

Lagerprogramm AT 5

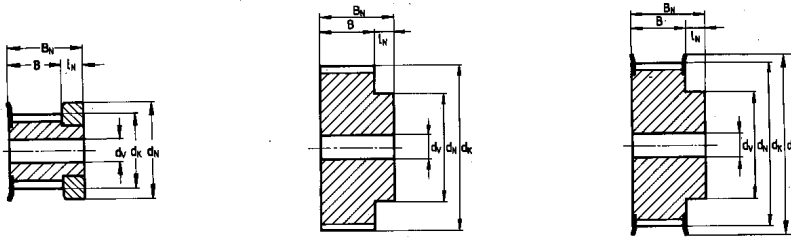

Ausführung 1

Ausführung - 0

Ausführung - 2

Bestellbezeichnung

Lagerscheibe	LS	28	AT5 / 48	- 0	Nabe	50 x 6
Gesamtbreite						
Teilung						
Zähnezahl						
Anzahl Bordscheiben						
Nabendurchmesser						
Nabenlänge						

	Bestellbezeichnung	d H7 ohne Nut mm	dk	Verzahnte Breite B	Bordscheibe dB mm	Werkstoff Zahnscheibe	Type	EUR/€ Stück
AT 5 Riemenbreite b=10 mm	22AT5/12-2Nb12x6	d=4	18,25	10mm	23x15x1	AlCuMg1	2	5,71 €
	22AT5/14-2Nb14x6	d=6	21,45	10mm	26x18x1	AlCuMg1	2	5,90 €
	22AT5/15-2Nb16x6	d=6	22,65	10mm	28x20x1	AlCuMg1	2	6,10 €
	22AT5/16-2Nb18x6	dv=6	24,24	10mm	30x22x1	AlCuMg1	2	6,19 €
	22AT5/18-2Nb20x6	d=6	27,43	10mm	34x24x1	AlCuMg1	2	6,29 €
	22AT5/19-2Nb22x6	d=6	29,02	10mm	35x25x1	AlCuMg1	2	6,81 €
	22AT5/20-2Nb24x6	d=6	30,61	10mm	36x26x1	AlCuMg1	2	7,02 €
	22AT5/22-2Nb24x6	d=6	33,79	10mm	39x29x1	AlCuMg1	2	7,11 €
	22AT5/24-2Nb26x6	d=8	36,98	10mm	42x30x1	AlCuMg1	2	7,33 €
	22AT5/25-2Nb26x6	d=8	38,57	10mm	43x31x1	AlCuMg1	2	7,82 €
	22AT5/27-2Nb30x6	d=8	41,75	10mm	47x35x1	AlCuMg1	2	8,15 €
	22AT5/30-2Nb34x6	d=8	46,53	10mm	52x40x1	AlCuMg1	2	8,48 €
	22AT5/32-2Nb38x6	d=8	49,71	10mm	55x43x1	AlCuMg1	2	9,09 €
	22AT5/36-2Nb38x6	d=8	56,08	10mm	61x49x1	AlCuMg1	2	9,85 €
	22AT5/40-2Nb40x6	d=8	62,44	10mm	68x54x1	AlCuMg1	2	10,54 €
	22AT5/44-2Nb50x6	d=8	68,81	10mm	74x60x1	AlCuMg1	2	10,84 €
	22AT5/48-0Nb50x6	d=8	75,17	10mm	0	AlCuMg1	0	11,26 €
	22AT5/48-2Nb50x6	d=9	75,17	10mm	80x66x1	AlCuMg1	2	17,71 €
22AT5/60-0Nb65x6	d=8	94,27	10mm	0	AlCuMg1	0	12,49 €	
22AT5/60-2Nb65x6	d=9	94,27	10mm	99x85x1	AlCuMg1	2	19,27 €	
22AT5/72-0Nb80x6	d=8	113,37	10mm	0	AlCuMg1	0	13,87 €	

AT 5 Riemenbreite b=16 mm	28AT5/12-2Nb12x6	d=4	18,25	16mm	23x15x1	AlCuMg1	2	6,33 €
	28AT5/14-2Nb14x6	d=6	21,45	16mm	26x18x1	AlCuMg1	2	6,74 €
	28AT5/15-2Nb16x6	d=6	22,65	16mm	28x20x1	AlCuMg1	2	6,79 €
	28AT5/16-2Nb18x6	d=6	24,24	16mm	30x22x1	AlCuMg1	2	7,15 €
	28AT5/18-2Nb20x6	d=6	27,43	16mm	34x24x1	AlCuMg1	2	7,63 €
	28AT5/19-2Nb22x6	d=6	29,02	16mm	35x25x1	AlCuMg1	2	7,98 €
	28AT5/20-2Nb24x6	d=6	30,61	16mm	36x26x1	AlCuMg1	2	8,15 €
	28AT5/22-2Nb24x6	d=6	33,79	16mm	39x29x1	AlCuMg1	2	8,76 €
	28AT5/24-2Nb26x6	d=8	36,98	16mm	42x30x1	AlCuMg1	2	9,02 €
	28AT5/25-2Nb26x6	d=8	38,57	16mm	43x31x1	AlCuMg1	2	9,26 €
	28AT5/27-2Nb30x6	d=8	41,75	16mm	47x35x1	AlCuMg1	2	9,37 €
	28AT5/30-2Nb34x6	d=8	46,53	16mm	52x40x1	AlCuMg1	2	9,93 €
	28AT5/32-2Nb38x6	d=8	49,71	16mm	55x43x1	AlCuMg1	2	10,23 €
	28AT5/36-2Nb38x6	d=8	56,08	16mm	61x49x1	AlCuMg1	2	11,16 €
	28AT5/40-2Nb40x6	d=8	62,44	16mm	68x54x1	AlCuMg1	2	11,50 €
	28AT5/44-2Nb50x6	d=8	68,81	16mm	74x60x1	AlCuMg1	2	11,97 €
	28AT5/48-0Nb50x6	d=8	75,17	16mm	0	AlCuMg1	0	12,23 €
	28AT5/48-2Nb50x6	d=9	75,17	16mm	80x66x1	AlCuMg1	2	18,67 €
28AT5/60-0Nb65x6	d=8	94,27	16mm	0	AlCuMg1	0	14,09 €	
28AT5/60-2Nb65x6	d=9	94,27	16mm	99x85x1	AlCuMg1	2	20,88 €	
28AT5/72-0Nb80x6	d=8	113,37	16mm	0	AlCuMg1	0	16,30 €	

Lagerprogramm AT 5

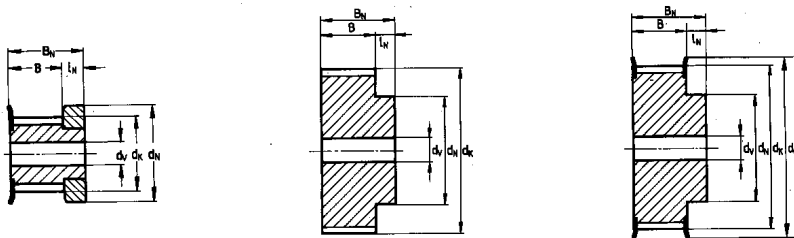

Ausführung 1

Ausführung - 0

Ausführung - 2

Bestellbezeichnung

Lagerscheibe	LS	46	AT5 /	60	-	0	Nabe	65 x	6
Gesamtbreite									
Teilung									
Zähnezahl									
Anzahl Bordscheiben									
Nabendurchmesser									
Nabenlänge									

Bestellbezeichnung	d H7 ohne Nut mm	dk	Verzahnte Breite B	Bordscheibe dB mm	Werkstoff Zahnscheibe	Type	EUR/€ Stück
--------------------	------------------	----	--------------------	-------------------	-----------------------	------	-------------

AT 5	Bestellbezeichnung	d H7 ohne Nut mm	dk	Verzahnte Breite B	Bordscheibe dB mm	Werkstoff Zahnscheibe	Type	EUR/€ Stück
Riemenbreite b=25 mm	38AT5/12-2Nb12x6	d=4	18,25	25mm	23x15x1	AlCuMg1	2	7,76 €
	38AT5/14-2Nb14x6	d=6	21,45	25mm	26x18x1	AlCuMg1	2	8,48 €
	38AT5/15-2Nb16x6	d=6	22,65	25mm	28x20x1	AlCuMg1	2	8,62 €
	38AT5/16-2Nb18x6	d=6	24,24	25mm	30x22x1	AlCuMg1	2	8,68 €
	38AT5/18-2Nb20x6	d=6	27,43	25mm	34x24x1	AlCuMg1	2	8,88 €
	38AT5/19-2Nb22x6	d=6	29,02	25mm	35x25x1	AlCuMg1	2	9,02 €
	38AT5/20-2Nb24x6	d=6	30,61	25mm	36x26x1	AlCuMg1	2	9,95 €
	38AT5/22-2Nb24x6	d=6	33,79	25mm	39x29x1	AlCuMg1	2	10,17 €
	38AT5/24-2Nb26x6	d=8	36,98	25mm	42x30x1	AlCuMg1	2	10,41 €
	38AT5/25-2Nb26x6	d=8	38,57	25mm	43x31x1	AlCuMg1	2	10,58 €
	38AT5/27-2Nb30x6	d=8	41,75	25mm	47x35x1	AlCuMg1	2	11,06 €
	38AT5/30-2Nb34x6	d=8	46,53	25mm	52x40x1	AlCuMg1	2	11,48 €
	38AT5/32-2Nb38x6	d=8	49,71	25mm	55x43x1	AlCuMg1	2	12,38 €
	38AT5/36-2Nb38x6	d=8	56,08	25mm	61x49x1	AlCuMg1	2	13,18 €
	38AT5/40-2Nb40x6	d=8	62,44	25mm	68x54x1	AlCuMg1	2	15,18 €
	38AT5/44-2Nb50x6	d=8	68,81	25mm	74x60x1	AlCuMg1	2	15,57 €
	38AT5/48-0Nb50x6	d=8	75,17	25mm	0	AlCuMg1	0	15,96 €
	38AT5/48-2Nb50x6	d=8	75,17	25mm	80x66x1	AlCuMg1	2	22,40 €
38AT5/60-0Nb65x6	d=8	94,27	25mm	0	AlCuMg1	0	19,51 €	
38AT5/60-2Nb65x6	d=8	94,27	25mm	99x85x1	AlCuMg1	2	26,29 €	
38AT5/72-0Nb80x6	d=8	113,37	25mm	0	AlCuMg1	0	21,56 €	

AT 5	Bestellbezeichnung	d H7 ohne Nut mm	dk	Verzahnte Breite B	Bordscheibe dB mm	Werkstoff Zahnscheibe	Type	EUR/€ Stück
Riemenbreite b=32 mm	46AT5/15-2Nb16x6	d=6	22,65	32mm	28x20x1	AlCuMg1	2	10,36 €
	46AT5/16-2Nb18x6	d=6	24,24	32mm	30x22x1	AlCuMg1	2	10,45 €
	46AT5/18-2Nb20x6	d=6	27,43	32mm	34x24x1	AlCuMg1	2	10,67 €
	46AT5/19-2Nb22x6	d=6	29,02	32mm	35x25x1	AlCuMg1	2	10,82 €
	46AT5/20-2Nb24x6	d=6	30,61	32mm	36x26x1	AlCuMg1	2	11,19 €
	46AT5/22-2Nb24x6	d=6	33,79	32mm	39x29x1	AlCuMg1	2	11,91 €
	46AT5/24-2Nb26x6	d=8	36,98	32mm	42x30x1	AlCuMg1	2	12,64 €
	46AT5/25-2Nb26x6	d=8	38,57	32mm	43x31x1	AlCuMg1	2	13,18 €
	46AT5/27-2Nb30x6	d=8	41,75	32mm	47x35x1	AlCuMg1	2	14,05 €
	46AT5/30-2Nb34x6	d=8	46,53	32mm	52x40x1	AlCuMg1	2	15,05 €
	46AT5/32-2Nb38x6	d=8	49,71	32mm	55x43x1	AlCuMg1	2	15,87 €
	46AT5/36-2Nb38x6	d=8	56,08	32mm	61x49x1	AlCuMg1	2	17,26 €
	46AT5/40-2Nb40x6	d=8	62,44	32mm	68x54x1	AlCuMg1	2	18,64 €
	46AT5/44-2Nb50x6	d=8	68,81	32mm	74x60x1	AlCuMg1	2	20,16 €
	46AT5/48-0Nb50x6	d=8	75,17	32mm	0	AlCuMg1	0	21,59 €
	46AT5/60-0Nb65x6	d=8	94,27	32mm	0	AlCuMg1	0	23,03 €
	46AT5/72-0Nb80x6	d=8	113,37	32mm	0	AlCuMg1	0	24,71 €

Lagerprogramm AT 10

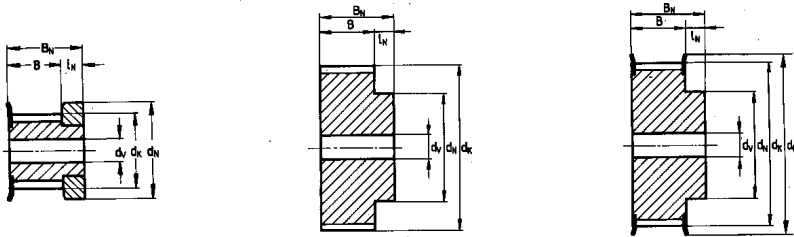

Ausführung 1

Ausführung - 0

Ausführung - 2

Bestellbezeichnung

Lagerscheibe	LS	50	AT10 /	60	-	0	Nabe	110 x 10
Gesamtbreite								
Teilung								
Zähnezahl								
Anzahl Bordscheiben								
Nabendurchmesser								
Nabenlänge								

Bestellbezeichnung	d H7 ohne Nut mm	dk	Verzahnte Breite B	Bordscheibe dB mm	Werkstoff Zahnscheibe	Type	EUR/€ Stück
--------------------	------------------	----	--------------------	-------------------	-----------------------	------	-------------

AT 10	Bestellbezeichnung	d H7 ohne Nut mm	dk	Verzahnte Breite B	Bordscheibe dB mm	Werkstoff Zahnscheibe	Type	EUR/€ Stück
Riemenbreite b=25 mm	42AT10/12-2Nb28x10	d=6	36,35	25mm	42x30x1	AlCuMg1	2	9,24 €
	42AT10/14-2Nb32x10	d=8	42,70	25mm	48x36x1	AlCuMg1	2	10,02 €
	42AT10/15-2Nb32x10	d=8	45,93	25mm	52x40x1	AlCuMg1	2	11,19 €
	42AT10/16-2Nb35x10	d=8	49,11	25mm	55x43x1	AlCuMg1	2	11,49 €
	42AT10/18-2Nb40x10	d=8	55,48	25mm	61x49x1	AlCuMg1	2	12,40 €
	42AT10/19-2Nb44x10	d=8	58,66	25mm	64x52x1	AlCuMg1	2	12,96 €
	42AT10/20-2Nb46x10	d=12	61,84	25mm	68x54x1	AlCuMg1	2	14,65 €
	42AT10/22-2Nb50x10	d=12	68,21	25mm	74x60x1	AlCuMg1	2	15,61 €
	42AT10/24-2Nb58x10	d=12	74,57	25mm	80x66x1	AlCuMg1	2	16,56 €
	42AT10/25-2Nb60x10	d=12	77,76	25mm	84x70x1	AlCuMg1	2	17,82 €
	42AT10/27-2Nb60x10	d=12	84,12	25mm	90x76x1	AlCuMg1	2	19,64 €
	42AT10/30-2Nb60x10	d=12	93,67	25mm	99x85x1	AlCuMg1	2	20,77 €
	42AT10/32-2Nb65x10	d=12	100,04	25mm	106x92x1	AlCuMg1	2	23,30 €
	42AT10/36-2Nb70x10	d=16	112,77	25mm	118x104x1,5	AlCuMg1	2	26,66 €
	42AT10/40-2Nb80x10	d=16	125,50	25mm	131x117x1,5	AlCuMg1	2	32,17 €
	42AT10/44-2Nb90x10	d=16	138,24	25mm	144x130x1,5	AlCuMg1	2	35,73 €
42AT10/48-0Nb95x10	d=16	150,97	25mm	0	AlCuMg1	0	39,54 €	
42AT10/60-0Nb110x10	d=16	189,17	25mm	0	AlCuMg1	0	51,25 €	

AT 10	Bestellbezeichnung	d H7 ohne Nut mm	dk	Verzahnte Breite B	Bordscheibe dB mm	Werkstoff Zahnscheibe	Type	EUR/€ Stück
Riemenbreite b=32 mm	50AT10/18-2Nb40x10	d=8	55,48	32mm	52x40x1	AlCuMg1	2	14,05 €
	50AT10/19-2Nb44x10	d=8	58,66	32mm	55x43x1	AlCuMg1	2	14,87 €
	50AT10/20-2Nb46x10	d=12	61,84	32mm	61x49x1	AlCuMg1	2	16,87 €
	50AT10/22-2Nb50x10	d=12	68,21	32mm	64x52x1	AlCuMg1	2	18,47 €
	50AT10/24-2Nb58x10	d=12	74,57	32mm	68x54x1	AlCuMg1	2	20,07 €
	50AT10/25-2Nb60x10	d=12	77,76	32mm	74x60x1	AlCuMg1	2	20,38 €
	50AT10/27-2Nb60x10	d=12	84,12	32mm	80x66x1	AlCuMg1	2	22,37 €
	50AT10/30-2Nb60x10	d=12	93,67	32mm	84x70x1	AlCuMg1	2	24,11 €
	50AT10/32-2Nb65x10	d=12	100,04	32mm	90x76x1	AlCuMg1	2	26,36 €
	50AT10/36-2Nb70x10	d=16	112,77	32mm	99x85x1	AlCuMg1	2	31,61 €
	50AT10/40-2Nb80x10	d=16	125,50	32mm	106x92x1	AlCuMg1	2	36,20 €
	50AT10/44-2Nb90x10	d=16	138,24	32mm	118x104x1,5	AlCuMg1	2	40,24 €
	50AT10/48-0Nb95x10	d=16	150,97	32mm	131x117x1,5	AlCuMg1	2	42,58 €
50AT10/60-0Nb110x10	d=16	189,17	32mm	144x130x1,5	AlCuMg1	2	57,71 €	

Lagerprogramm AT 10

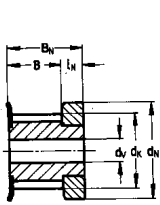

Ausführung 1

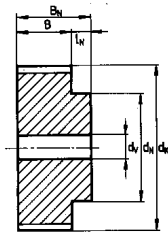

Ausführung - 0

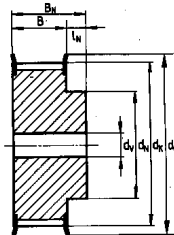

Ausführung - 2

Bestellbezeichnung

Lagerscheibe	LS	70	AT10/	60	-	0	Nabe	110 x 10
Gesamtbreite								
Teilung								
Zähnezahl								
Anzahl Bordscheiben								
Nabendurchmesser								
Nabenlänge								

Bestellbezeichnung	d H7 ohne Nut mm	dk	Verzahnte Breite B	Bordscheibe dB mm	Werkstoff Zahnscheibe	Type	EUR/€ Stück
--------------------	------------------	----	--------------------	-------------------	-----------------------	------	-------------

AT 10 Riemenbreite b=50 mm	70AT10/18-2Nb40x10	d=8	55,48	50mm	52x40x1	AlCuMg1	2	18,99 €
	70AT10/19-2Nb44x10	d=8	58,66	50mm	55x43x1	AlCuMg1	2	20,07 €
	70AT10/20-2Nb46x10	d=12	61,84	50mm	61x49x1	AlCuMg1	2	21,07 €
	70AT10/22-2Nb50x10	d=12	68,21	50mm	64x52x1	AlCuMg1	2	23,08 €
	70AT10/24-2Nb58x10	d=12	74,57	50mm	68x54x1	AlCuMg1	2	24,51 €
	70AT10/25-2Nb60x10	d=12	77,76	50mm	74x60x1	AlCuMg1	2	25,10 €
	70AT10/27-2Nb60x10	d=12	84,12	50mm	80x66x1	AlCuMg1	2	27,75 €
	70AT10/30-2Nb60x10	d=12	93,67	50mm	84x70x1	AlCuMg1	2	30,44 €
	70AT10/32-2Nb65x10	d=12	100,04	50mm	90x76x1	AlCuMg1	2	33,56 €
	70AT10/36-2Nb70x10	d=16	112,77	50mm	99x85x1	AlCuMg1	2	41,02 €
	70AT10/40-2Nb80x10	d=16	125,50	50mm	106x92x1	AlCuMg1	2	45,87 €
	70AT10/44-2Nb90x10	d=16	138,24	50mm	118x104x1,5	AlCuMg1	2	49,08 €
	70AT10/48-0Nb95x10	d=16	150,97	50mm	131x117x1,5	AlCuMg1	2	52,33 €
	70AT10/60-0Nb110x10	d=16	189,17	50mm	144x130x1,5	AlCuMg1	2	71,32 €

Lagerprogramm 3M ungebohrt

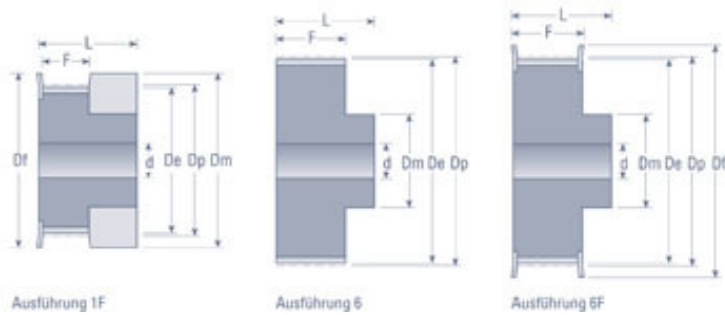

Bestellbezeichnung	d (mm)	dK	Verzahnte Breite B	dB	Werkstoff	Type	EUR/€ Stück
--------------------	--------	----	--------------------	----	-----------	------	-------------

3M Riemenbreite b=9 mm	10 3M9 1F	-	8,79	10,2	13,0	AL	1F	4,01 €
	12 3M9 1F	-	10,70	10,2	15,0	AL	1F	4,15 €
	15 3M9 1F	-	13,56	10,2	17,5	AL	1F	4,45 €
	16 3M9 6F	4,0	14,52	12,8	18,0	AL	6F	4,73 €
	18 3M9 6F	6,0	16,43	12,8	19,5	AL	6F	5,32 €
	20 3M9 6F	6,0	18,34	12,9	23,0	AL	6F	5,48 €
	21 3M9 6F	6,0	19,29	12,10	25,0	AL	6F	5,62 €
	22 3M9 6F	6,0	20,25	12,11	25,0	AL	6F	6,06 €
	24 3M9 6F	6,0	22,16	12,12	25,0	AL	6F	6,22 €
	26 3M9 6F	6,0	24,07	12,13	28,0	AL	6F	6,67 €
	28 3M9 6F	6,0	25,98	12,14	32,0	AL	6F	6,97 €
	30 3M9 6F	6,0	27,89	12,15	32,0	AL	6F	7,25 €
	32 3M9 6F	6,0	29,80	12,16	36,0	AL	6F	7,55 €
	36 3M9 6F	6,0	33,62	13,4	38,0	AL	6F	8,30 €
	40 3M9 6F	6,0	27,44	13,5	42,0	AL	6F	8,44 €
	44 3M9 6F	6,0	41,26	13,6	48,0	AL	6F	10,21 €
	48 3M9 6	8,0	45,08	13,7	-	AL	6	10,96 €
60 3M9 6	8,0	56,54	13,8	-	AL	6	13,17 €	
72 3M9 6	8,0	67,99	13,9	-	AL	6	16,58 €	

3M Riemenbreite b=15 mm	10 3M15 1F	-	8,79	17,0	13,0	AL	1F	4,45 €
	12 3M15 1F	-	10,70	17,0	15,0	AL	1F	4,59 €
	14 3M15 1F	-	12,61	17,0	16,0	AL	1F	5,04 €
	15 3M15 1F	-	13,56	17,0	17,5	AL	1F	5,18 €
	16 3M15 6F	4,0	14,52	19,5	9,5	AL	6F	5,48 €
	18 3M15 6F	6,0	16,43	19,5	10,0	AL	6F	5,62 €
	20 3M15 6F	6,0	18,34	19,5	12,0	AL	6F	5,92 €
	21 3M15 6F	6,0	19,29	19,5	13,0	AL	6F	6,06 €
	22 3M15 6F	6,0	20,25	19,5	13,0	AL	6F	6,67 €
	24 3M15 6F	6,0	22,16	19,5	13,0	AL	6F	6,97 €
	26 3M15 6F	6,0	24,07	19,5	16,0	AL	6F	7,25 €
	28 3M15 6F	6,0	25,98	19,5	18,0	AL	6F	7,41 €
	30 3M15 6F	6,0	27,89	19,5	19,0	AL	6F	8,00 €
	32 3M15 6F	6,0	29,80	19,5	22,0	AL	6F	8,58 €
	36 3M15 6F	6,0	33,62	20,0	26,0	AL	6F	9,91 €
	40 3M15 6F	6,0	37,44	20,0	28,0	AL	6F	10,07 €
	44 3M15 6F	6,0	41,26	20,0	33,0	AL	6F	11,84 €
48 3M15 6	8,0	45,08	20,0	33,0	AL	6	13,03 €	
60 3M15 6	8,0	56,54	20,0	33,0	AL	6	15,99 €	
72 3M15 6	8,0	67,99	20,0	33,0	AL	6	19,25 €	

Lagerprogramm 5M ungebohrt

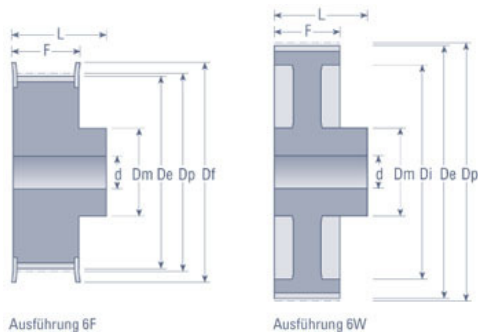

Ausführung 6F

Ausführung 6W

Bestellbezeichnung	d (mm)	dK	Verzahnte Breite B	dB	Werkstoff	Type	EUR/€ Stück
--------------------	--------	----	--------------------	----	-----------	------	-------------

5M Riemenbreite b=9mm	12 5M9 6F	4,0	17,96	14,5	25,0	ST	6F	4,29 €
	14 5M9 6F	6,0	21,14	14,5	25,0	ST	6F	4,59 €
	15 5M9 6F	6,0	22,73	14,5	28,0	ST	6F	4,73 €
	16 5M9 6F	6,0	24,32	14,5	28,0	ST	6F	5,04 €
	18 5M9 6F	6,0	27,51	14,5	32,0	ST	6F	5,48 €
	20 5M9 6F	6,0	30,69	14,5	36,0	ST	6F	5,92 €
	21 5M9 6F	6,0	32,28	14,5	38,0	ST	6F	6,22 €
	22 5M9 6F	6,0	33,87	14,5	38,0	ST	6F	6,53 €
	24 5M9 6F	6,0	37,06	14,5	42,0	ST	6F	6,81 €
	26 5M9 6F	6,0	40,24	14,5	44,0	ST	6F	7,11 €
	28 5M9 6F	6,0	43,42	14,5	48,0	ST	6F	7,41 €
	30 5M9 6F	6,0	46,60	14,5	51,0	ST	6F	7,69 €
	32 5M9 6F	8,0	49,79	14,5	54,0	ST	6F	8,30 €
	36 5M9 6F	8,0	56,16	14,5	60,0	ST	6F	9,02 €
	40 5M9 6F	8,0	62,52	14,5	71,0	ST	6F	9,47 €
	44 5M9 6W	8,0	68,89	14,5	-	AL	6W	11,26 €
	48 5M9 6W	8,0	75,25	14,5	-	AL	6W	12,14 €
60 5M9 6W	8,0	94,35	14,5	-	AL	6W	15,25 €	
72 5M9 6W	8,0	113,45	14,5	-	AL	6W	18,37 €	

5M Riemenbreite b=15mm	12 5M15 6F	4,0	17,96	20,5	25,0	ST	6F	4,89 €
	14 5M15 6F	6,0	21,14	20,5	25,0	ST	6F	5,18 €
	15 5M15 6F	6,0	22,73	20,5	28,0	ST	6F	5,48 €
	16 5M15 6F	6,0	24,32	20,5	28,0	ST	6F	5,92 €
	18 5M15 6F	6,0	27,51	20,5	32,0	ST	6F	6,22 €
	20 5M15 6F	6,0	30,69	20,5	36,0	ST	6F	6,53 €
	21 5M15 6F	6,0	32,28	20,5	38,0	ST	6F	6,97 €
	22 5M15 6F	6,0	33,87	20,5	38,0	ST	6F	7,25 €
	24 5M15 6F	6,0	37,06	20,5	42,0	ST	6F	7,69 €
	26 5M15 6F	6,0	40,24	20,5	44,0	ST	6F	7,85 €
	28 5M15 6F	6,0	43,42	20,5	48,0	ST	6F	8,30 €
	30 5M15 6F	6,0	46,60	20,5	51,0	ST	6F	9,02 €
	32 5M15 6F	8,0	49,79	20,5	54,0	ST	6F	9,77 €
	36 5M15 6F	8,0	56,16	20,5	60,0	ST	6F	10,37 €
	40 5M15 6F	8,0	62,52	20,5	71,0	ST	6F	11,12 €
	44 5M15 6W	8,0	68,89	20,5	-	AL	6W	13,03 €
	48 5M15 6W	8,0	75,25	20,5	-	AL	6W	14,50 €
60 5M15 6W	8,0	94,35	20,5	-	AL	6W	17,90 €	
72 5M15 6W	8,0	113,45	20,5	-	AL	6W	21,47 €	

Lagerprogramm 5M ungebohrt

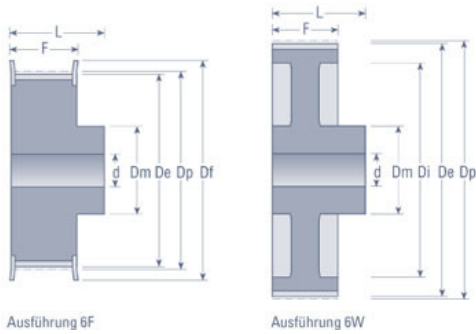

Ausführung 6F

Ausführung 6W

Bestellbezeichnung	d (mm)	dK	Verzahnte Breite B	dB	Werkstoff	Type	EUR/€ Stück
--------------------	--------	----	--------------------	----	-----------	------	-------------

5M Riemenbreite b=25mm	12 5M25 6F	4,0	17,96	30,5	25,0	ST	6F	6,06 €
	14 5M25 6F	6,0	21,14	30,5	25,0	ST	6F	6,53 €
	15 5M25 6F	6,0	22,73	30,5	28,0	ST	6F	6,81 €
	16 5M25 6F	6,0	24,32	30,5	28,0	ST	6F	7,11 €
	18 5M25 6F	6,0	27,51	30,5	32,0	ST	6F	7,41 €
	20 5M25 6F	6,0	30,69	30,5	36,0	ST	6F	7,69 €
	21 5M25 6F	6,0	32,28	30,5	38,0	ST	6F	8,16 €
	22 5M25 6F	6,0	33,87	30,5	38,0	ST	6F	8,58 €
	24 5M25 6F	6,0	37,06	30,5	42,0	ST	6F	9,32 €
	26 5M25 6F	6,0	40,24	30,5	44,0	ST	6F	10,07 €
	28 5M25 6F	6,0	43,42	30,5	48,0	ST	6F	10,65 €
	30 5M25 6F	6,0	46,60	30,5	51,0	ST	6F	11,70 €
	32 5M25 6F	8,0	49,79	30,5	54,0	ST	6F	12,59 €
	36 5M25 6F	8,0	56,16	30,5	60,0	ST	6F	13,33 €
	40 5M25 6F	8,0	62,52	30,5	71,0	ST	6F	15,25 €
	44 5M25 6W	8,0	68,89	30,5	-	AL	6W	18,37 €
	48 5M25 6W	8,0	75,25	30,5	-	AL	6W	19,84 €
	60 5M25 6W	8,0	94,35	30,5	-	AL	6W	24,73 €
	72 5M25 6W	8,0	113,45	30,5	-	AL	6W	29,46 €

Lagerprogramm 8M ungebohrt

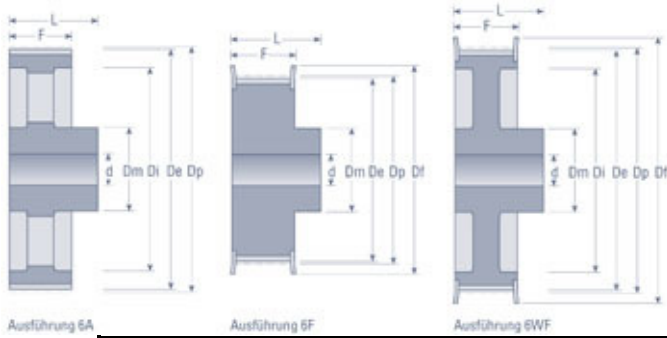

Bestellbezeichnung	d (mm)	dK	Verzahnte Breite B	dB	Werkstoff	Type	EUR/€ Stück
--------------------	--------	----	--------------------	----	-----------	------	-------------

8M Riemenbreite b=20mm	Bestellbezeichnung	d (mm)	dK	Verzahnte Breite B	dB	Werkstoff	Type	EUR/€ Stück
	22 8M 20 6F	12	54,65	28	60,0	ST	6F	9,91 €
24 8M 20 6F	12	59,75	28	66,0	ST	6F	9,57 €	
26 8M 20 6F	12	64,84	28	71,0	ST	6F	11,40 €	
28 8M 20 6F	15	70,08	28	75,0	ST	6F	12,14 €	
30 8M 20 6F	15	75,13	28	83,0	ST	6F	12,89 €	
32 8M 20 6F	15	80,16	28	87,0	ST	6F	14,06 €	
34 8M 20 6F	15	85,22	28	91,0	ST	6F	14,96 €	
36 8M 20 6F	15	90,30	28	98,5	ST	6F	15,71 €	
38 8M 20 6F	15	95,39	28	103,0	ST	6F	16,88 €	
40 8M 20 6F	15	100,49	28	106,0	GG	6F	18,37 €	
44 8M 20 6F	15	110,67	28	119,0	GG	6F	21,47 €	
48 8M 20 6F	15	120,86	28	127,0	GG	6F	23,54 €	
56 8M 20 6WF	15	141,23	28	148,0	GG	6WF	30,49 €	
64 8M 20 6WF	15	161,60	28	168,0	GG	6WF	35,83 €	
72 8M 20 6WF	15	181,97	28	192,0	GG	6WF	36,07 €	
80 8M 20 6A	15	202,35	28	-	GG	6A	42,64 €	
90 8M 20 6A	15	227,81	28	-	GG	6A	49,60 €	
112 8M 20 6A	18	283,83	28	-	GG	6A	64,71 €	
144 8M 20 6A	20	365,32	28	-	GG	6A	81,73 €	
168 8M 20 6A	20	426,44	28	-	GG	6A	123,64 €	
192 8M 20 6A	20	487,55	28	-	GG	6A	150,14 €	

8M Riemenbreite b=30 mm	Bestellbezeichnung	d (mm)	dK	Verzahnte Breite B	dB	Werkstoff	Type	EUR/€ Stück
	22 8M 30 6F	12	54,65	38	60,0	ST	6F	11,04 €
24 8M 30 6F	12	59,75	38	66,0	ST	6F	11,50 €	
26 8M 30 6F	12	64,84	38	71,0	ST	6F	12,00 €	
28 8M 30 6F	15	70,08	38	75,0	ST	6F	12,35 €	
30 8M 30 6F	15	75,13	38	83,0	ST	6F	15,41 €	
32 8M 30 6F	15	80,16	38	87,0	ST	6F	16,29 €	
34 8M 30 6F	15	85,22	38	91,0	ST	6F	17,18 €	
36 8M 30 6F	15	90,30	38	98,5	ST	6F	18,37 €	
38 8M 30 6F	15	95,39	38	103,0	ST	6F	19,70 €	
40 8M 30 6F	15	100,49	38	106,0	GG	6F	19,78 €	
44 8M 30 6F	15	110,67	38	119,0	GG	6F	24,59 €	
48 8M 30 6F	15	120,86	38	127,0	GG	6F	27,39 €	
56 8M 30 6WF	15	141,23	38	148,0	GG	6WF	36,27 €	
64 8M 30 6WF	15	161,60	38	168,0	GG	6WF	41,17 €	
72 8M 30 6WF	15	181,97	38	192,0	GG	6WF	45,76 €	
80 8M 30 6A	15	202,35	38	-	GG	6A	52,71 €	
90 8M 30 6A	15	227,81	38	-	GG	6A	58,63 €	
112 8M 30 6A	18	283,83	38	-	GG	6A	66,34 €	
144 8M 30 6A	20	365,32	38	-	GG	6A	83,96 €	
168 8M 30 6A	20	426,44	38	-	GG	6A	125,85 €	
192 8M 30 6A	20	487,55	38	-	GG	6A	152,50 €	

Lagerprogramm 8M ungebohrt

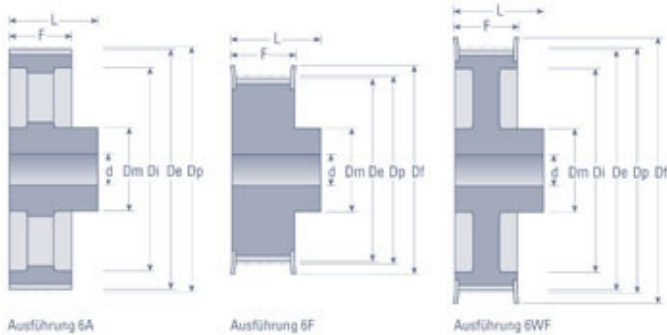

Bestellbezeichnung	d (mm)	dK	Verzahnte Breite B	dB	Werkstoff	Type	EUR/€ Stück
--------------------	--------	----	--------------------	----	-----------	------	-------------

8M Riemenbreite b=50mm	22 8M 50 6F	12	54,65	60	60,0	ST	6F	14,96 €
	24 8M 50 6F	12	59,75	60	66,0	ST	6F	15,55 €
	26 8M 50 6F	12	64,84	60	71,0	ST	6F	17,04 €
	28 8M 50 6F	15	70,08	60	75,0	ST	6F	18,81 €
	30 8M 50 6F	15	75,13	60	83,0	ST	6F	19,70 €
	32 8M 50 6F	15	80,16	60	87,0	ST	6F	21,47 €
	34 8M 50 6F	15	85,22	60	91,0	ST	6F	22,66 €
	36 8M 50 6F	15	90,30	60	98,5	ST	6F	24,29 €
	38 8M 50 6F	15	95,39	60	103,0	ST	6F	26,20 €
	40 8M 50 6F	18	100,49	60	106,0	GG	6F	24,53 €
	44 8M 50 6F	18	110,67	60	119,0	GG	6F	28,68 €
	48 8M 50 6F	18	120,86	60	127,0	GG	6F	32,24 €
	56 8M 50 10WF	18	141,23	60	148,0	GG	10WF	39,51 €
	64 8M 50 10WF	18	161,60	60	168,0	GG	10WF	47,69 €
	72 8M 50 10WF	18	181,97	60	192,0	GG	10WF	54,78 €
	80 8M 50 10A	18	202,35	60	-	GG	10A	65,60 €
	90 8M 50 10A	18	227,81	60	-	GG	10A	68,31 €
	112 8M 50 10A	18	283,83	60	-	GG	10A	77,08 €
144 8M 50 10A	20	365,32	60	-	GG	10A	116,97 €	
168 8M 50 10A	20	426,44	60	-	GG	10A	160,21 €	
192 8M 50 10A	20	487,55	60	-	GG	10A	205,81 €	

8M Riemenbreite b=85 mm	22 8M 85 6F	12	54,65	95	60,0	ST	6F	19,09 €
	24 8M 85 6F	12	59,75	95	66,0	ST	6F	20,72 €
	26 8M 85 6F	12	64,84	95	71,0	ST	6F	22,21 €
	28 8M 85 6F	15	70,08	95	75,0	ST	6F	25,62 €
	30 8M 85 6F	15	75,13	95	83,0	ST	6F	27,39 €
	32 8M 85 6F	15	80,16	95	87,0	ST	6F	28,72 €
	34 8M 85 6F	15	85,22	95	91,0	ST	6F	31,10 €
	36 8M 85 6F	15	90,30	95	98,5	ST	6F	34,34 €
	38 8M 85 6F	15	95,39	95	103,0	ST	6F	35,83 €
	40 8M 85 6F	18	100,49	95	106,0	GG	6F	39,53 €
	44 8M 85 6F	18	110,67	95	119,0	GG	6F	44,13 €
	48 8M 85 6F	18	120,86	95	127,0	GG	6F	50,35 €
	56 8M 85 6F	20	141,23	95	148,0	GG	6F	61,00 €
	64 8M 85 10WF	20	161,60	95	168,0	GG	10WF	73,15 €
	72 8M 85 10WF	20	181,97	95	192,0	GG	10WF	83,96 €
	80 8M 85 10A	20	202,35	95	-	GG	10A	89,14 €
	90 8M 85 10A	20	227,81	95	-	GG	10A	104,39 €
	112 8M 85 10A	24	283,83	95	-	GG	10A	131,05 €
	144 8M 85 10A	24	365,32	95	-	GG	10A	196,20 €
	168 8M 85 10A	24	426,44	95	-	GG	10A	210,56 €
192 8M 85 10A	24	487,55	95	-	GG	10A	266,53 €	

Lagerprogramm 14M ungebohrt

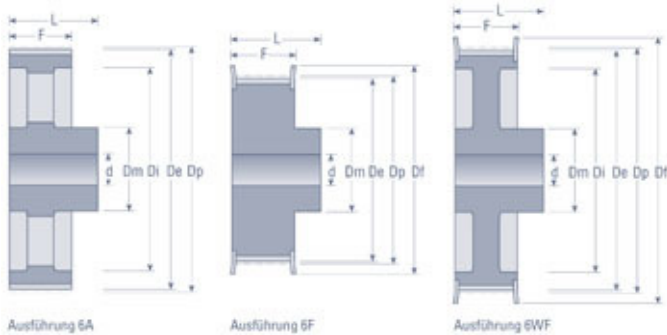

Bestellbezeichnung	d (mm)	dK	Verzahnte Breite B	dB	Werkstoff	Type	EUR/€ Stück
--------------------	--------	----	--------------------	----	-----------	------	-------------

14M								
Riemenbreite b=40 mm	28 14M 40 6F	24	122,12	54	127	GG	6F	37,76 €
	29 14M 40 6F	24	126,57	54	138	GG	6F	40,72 €
	30 14M 40 6F	24	130,99	54	138	GG	6F	43,38 €
	32 14M 40 6F	24	139,88	54	154	GG	6F	46,50 €
	34 14M 40 6F	24	148,79	54	160	GG	6F	51,82 €
	36 14M 40 6F	24	157,68	54	168	GG	6F	56,41 €
	38 14M 40 6F	24	166,60	54	183	GG	6F	57,90 €
	40 14M 40 6F	24	175,49	54	188	GG	6F	64,85 €
	44 14M 40 6F	24	193,28	54	211	GG	6F	70,05 €
	48 14M 40 6WF	24	211,11	54	226	GG	6WF	83,96 €
	56 14M 40 6WF	28	246,76	54	256	GG	6WF	95,36 €
	64 14M 40 6WF	28	282,41	54	296	GG	6WF	114,46 €
	72 14M 40 6A	28	318,06	54	-	GG	6A	118,16 €
	80 14M 40 6A	28	353,71	54	-	GG	6A	122,01 €
	90 14M 40 6A	28	398,28	54	-	GG	6A	137,27 €
	112 14M 40 6A	28	496,32	54	-	GG	6A	167,77 €
	144 14M 40 6A	28	638,92	54	-	GG	6A	250,84 €
	168 14M 40 6A	28	745,87	54	-	GG	6A	330,05 €
192 14M 40 6A	28	852,82	54	-	GG	6A	422,90 €	

14M								
Riemenbreite b=55 mm	28 14M 55 6F	24	122,12	70	127	GG	6F	47,23 €
	29 14M 55 6F	24	126,57	70	138	GG	6F	49,30 €
	30 14M 55 6F	24	130,99	70	138	GG	6F	51,08 €
	32 14M 55 6F	24	139,88	70	154	GG	6F	54,78 €
	34 14M 55 6F	24	148,79	70	160	GG	6F	58,63 €
	36 14M 55 6F	24	157,68	70	168	GG	6F	64,11 €
	38 14M 55 6F	24	166,60	70	183	GG	6F	68,70 €
	40 14M 55 6F	24	175,49	70	188	GG	6F	73,89 €
	44 14M 55 6F	24	193,28	70	211	GG	6F	80,84 €
	48 14M 55 10WF	24	211,11	70	226	GG	10WF	97,14 €
	56 14M 55 10WF	28	246,76	70	256	GG	10WF	109,86 €
	64 14M 55 10WF	28	282,41	70	296	GG	10WF	130,31 €
	72 14M 55 10A	28	318,06	70	-	GG	10A	133,41 €
	80 14M 55 10A	28	353,71	70	-	GG	10A	144,97 €
	90 14M 55 10A	28	398,28	70	-	GG	10A	164,64 €
	112 14M 55 10A	28	496,32	70	-	GG	10A	202,85 €
	144 14M 55 10A	28	638,92	70	-	GG	10A	304,88 €
	168 14M 55 10A	28	745,87	70	-	GG	10A	396,38 €
192 14M 55 10A	28	852,82	70	-	GG	10A	472,65 €	
216 14M 55 10A	28	959,76	70	-	GG	10A	576,45 €	

Lagerprogramm 14M ungebohrt

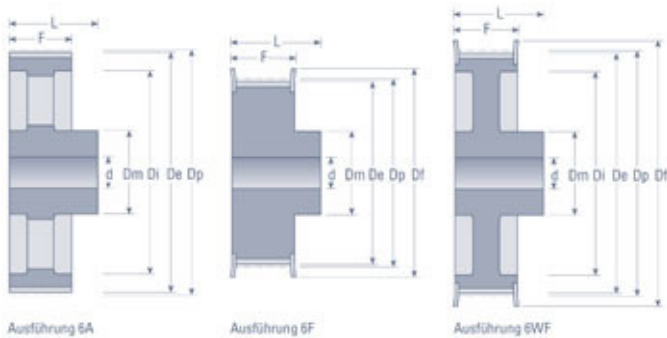

Bestellbezeichnung	d (mm)	dK	Verzahnte Breite B	dB	Werkstoff	Type	EUR/€ Stück
--------------------	--------	----	--------------------	----	-----------	------	-------------

14M Riemenbreite b=85 mm	28 14M85 6F	24	122,12	102	127	GG	6F	57,90 €
	29 14M85 6F	24	126,57	102	138	GG	6F	60,70 €
	30 14M85 6F	24	130,99	102	138	GG	6F	62,49 €
	32 14M85 6F	24	139,88	102	154	GG	6F	69,30 €
	34 14M85 6F	24	148,79	102	160	GG	6F	77,74 €
	36 14M85 6F	32	157,68	102	168	GG	6F	85,29 €
	38 14M85 6F	32	166,60	102	183	GG	6F	92,26 €
	40 14M85 6F	32	175,49	102	188	GG	6F	99,21 €
	44 14M85 6F	32	193,28	102	211	GG	6F	114,46 €
	48 14M85 6F	32	211,11	102	226	GG	6F	129,72 €
	56 14M85 10WF	32	246,76	102	256	GG	10WF	150,89 €
	64 14M85 10WF	32	282,41	102	296	GG	10WF	175,46 €
	72 14M85 10A	32	318,06	102	-	GG	10A	179,91 €
	80 14M85 10A	32	353,71	102	-	GG	10A	198,12 €
	90 14M85 10A	32	398,28	102	-	GG	10A	221,08 €
	112 14M85 10A	32	496,32	102	-	GG	10A	271,27 €
	144 14M85 10A	32	638,92	102	-	GG	10A	388,84 €
	168 14M85 10A	32	745,87	102	-	GG	10A	518,40 €
	192 14M85 10A	32	852,82	102	-	GG	10A	617,45 €
216 14M85 10A	32	959,76	102	-	GG	10A	759,46 €	

Lagerprogramm 5M TL

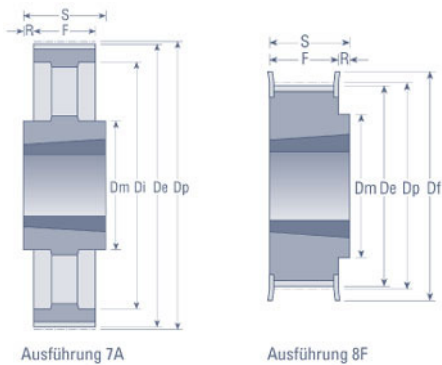

	Bestellbezeichnung	d (mm)	dK	Verzahnte Breite B	dB	Werkstoff	Type	EUR/€ Stück
5M Riemenbreite b=15 mm	34 5M 15 8F 1008	43	52,97	20,5	57	ST	8F	14,22 €
	36 5M 15 8F 1108	44	56,16	20,5	60	ST	8F	14,66 €
	38 5M 15 8F 1108	48	59,34	20,5	66	ST	8F	15,71 €
	40 5M 15 8F 1108	52	62,52	20,5	71	ST	8F	16,88 €
	44 5M 15 8F 1108	54	68,89	20,5	75	ST	8F	18,37 €
	48 5M 15 8F 1210	64	75,25	20,5	83	ST	8F	20,89 €
	56 5M 15 8F 1210	70	87,99	20,5	93	GG	8F	22,80 €
	64 5M 15 8F 1210	78	100,72	20,5	106	GG	8F	26,34 €
	72 5M 15 8F 1610	90	113,59	20,5	119	GG	8F	27,83 €
	80 5M 15 8F 1610	92	126,18	20,5	135	GG	8F	30,05 €
	90 5M 15 7A 1610	92	142,10	20,5	-	GG	7A	31,10 €
	112 5M 15 7A 1610	92	177,11	20,5	-	GG	7A	35,99 €
	136 5M 15 7A 2012	106	215,31	20,5	-	GG	7A	43,38 €
	150 5M 15 7A 2012	106	237,59	20,5	-	GG	7A	53,17 €

Lagerprogramm 8M TL

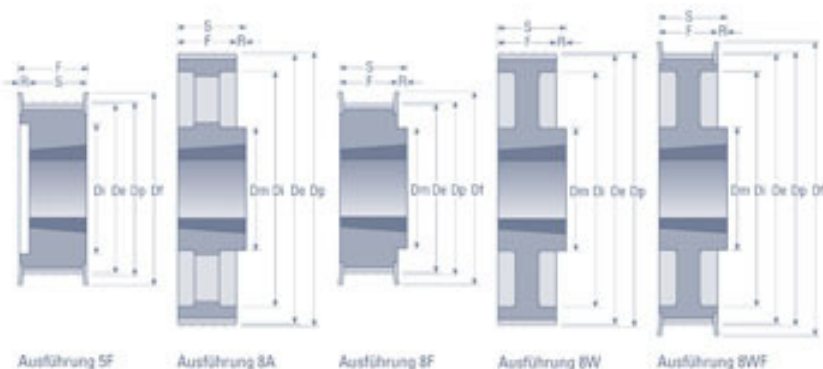

Bestellbezeichnung	d (mm)	dK	Verzahnte Breite B	dB	Werkstoff	Type	EUR/€ Stück
--------------------	--------	----	--------------------	----	-----------	------	-------------

8M Riemenbreite b=20 mm	22 8M20 5F 1008	-	54,65	28	60,0	GG	5F	14,36 €
	24 8M20 5F 1108	-	59,75	28	66,0	GG	5F	14,66 €
	26 8M20 5F 1108	-	54,84	28	71,0	GG	5F	15,25 €
	28 8M20 5F 1108	-	70,08	28	75,0	GG	5F	15,41 €
	30 8M20 5F 1108	-	75,13	28	83,0	GG	5F	15,99 €
	32 8M20 5F 1610	-	80,16	28	87,0	GG	5F	16,43 €
	34 8M20 5F 1610	-	85,22	28	91,0	GG	5F	17,46 €
	36 8M20 5F 1610	-	90,30	28	98,5	GG	5F	18,21 €
	38 8M20 5F 1610	-	95,39	28	103,0	GG	5F	19,09 €
	40 8M20 5F 1610	-	100,49	28	106,0	GG	5F	20,72 €
	44 8M20 8F 2012	93	110,67	28	119,0	GG	8F	23,24 €
	48 8M20 8F 2012	96	120,86	28	127,0	GG	8F	26,34 €
	56 8M20 8F 2012	110	141,23	28	148,0	GG	8F	31,24 €
	64 8M20 8WF 2012	110	161,60	28	168,0	GG	8WF	38,79 €
	72 8M20 8WF 2012	110	181,97	28	192,0	GG	8WF	45,76 €
	80 8M20 8W 2012	110	202,35	28	-	GG	8W	51,82 €
90 8M20 8A 2012	110	227,81	28	-	GG	8A	57,90 €	

8M Riemenbreite b=30 mm	22 8M30 5F 1008	-	54,65	38	60,0	GG	5F	15,99 €
	24 8M30 5F 1108	-	59,75	38	66,0	GG	5F	16,29 €
	26 8M30 5F 1108	-	64,84	38	71,0	GG	5F	17,04 €
	28 8M30 5F 1210	-	70,08	38	75,0	ST	5F	17,64 €
	30 8M30 3F 1615	-	75,13	38	83,0	ST	3F	18,07 €
	32 8M30 3F 1615	-	80,16	38	87,0	GG	3F	18,51 €
	34 8M30 3F 1615	-	85,22	38	91,0	GG	3F	19,56 €
	36 8M30 3F 1615	-	90,30	38	98,5	GG	3F	20,28 €
	38 8M30 3F 1615	-	95,39	38	103,0	GG	3F	22,05 €
	40 8M30 3F 1615	-	100,49	38	106,0	GG	3F	23,24 €
	44 8M30 4F 2012	-	110,67	38	119,0	GG	4F	26,65 €
	48 8M30 4F 2012	-	120,86	38	127,0	GG	4F	29,77 €
	56 8M30 4F 2012	-	141,23	38	148,0	GG	4F	36,74 €
	64 8M30 8F 2517	125	161,60	38	168,0	GG	8F	43,82 €
	72 8M30 8WF 2517	125	181,97	38	192,0	GG	8WF	53,45 €
	80 8M30 8W 2517	125	202,35	38	-	GG	8W	59,37 €
	90 8M30 8A 2517	125	227,81	38	-	GG	8A	67,95 €
	112 8M30 8A 2517	125	283,83	38	-	GG	8A	82,33 €
144 8M30 8A 2517	125	365,69	38	-	GG	8A	108,98 €	

Lagerprogramm 8M TL

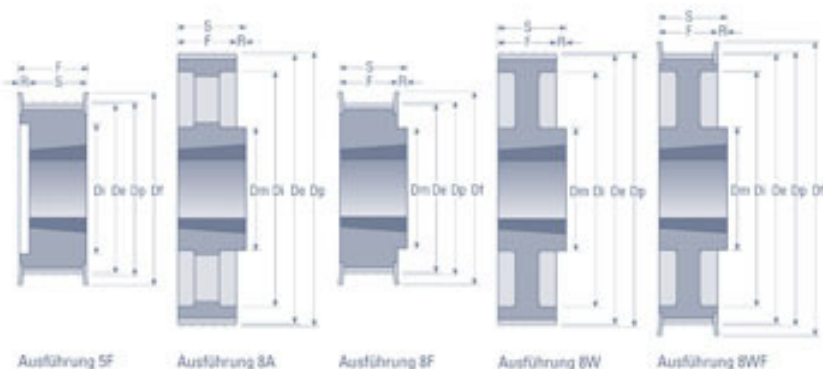

Bestellbezeichnung	d (mm)	dK	Verzahnte Breite B	dB	Werkstoff	Type	EUR/€ Stück
--------------------	--------	----	--------------------	----	-----------	------	-------------

8M Riemenbreite b=20 mm	22 8M20 5F 1008	-	54,65	28	60,0	GG	5F	14,36 €
	24 8M20 5F 1108	-	59,75	28	66,0	GG	5F	14,66 €
	26 8M20 5F 1108	-	54,84	28	71,0	GG	5F	15,25 €
	28 8M20 5F 1108	-	70,08	28	75,0	GG	5F	15,41 €
	30 8M20 5F 1108	-	75,13	28	83,0	GG	5F	15,99 €
	32 8M20 5F 1610	-	80,16	28	87,0	GG	5F	16,43 €
	34 8M20 5F 1610	-	85,22	28	91,0	GG	5F	17,46 €
	36 8M20 5F 1610	-	90,30	28	98,5	GG	5F	18,21 €
	38 8M20 5F 1610	-	95,39	28	103,0	GG	5F	19,09 €
	40 8M20 5F 1610	-	100,49	28	106,0	GG	5F	20,72 €
	44 8M20 8F 2012	93	110,67	28	119,0	GG	8F	23,24 €
	48 8M20 8F 2012	96	120,86	28	127,0	GG	8F	26,34 €
	56 8M20 8F 2012	110	141,23	28	148,0	GG	8F	31,24 €
	64 8M20 8WF 2012	110	161,60	28	168,0	GG	8WF	38,79 €
	72 8M20 8WF 2012	110	181,97	28	192,0	GG	8WF	45,76 €
	80 8M20 8W 2012	110	202,35	28	-	GG	8W	51,82 €
90 8M20 8A 2012	110	227,81	28	-	GG	8A	57,90 €	

8M Riemenbreite b=30 mm	22 8M30 5F 1008	-	54,65	38	60,0	GG	5F	15,99 €
	24 8M30 5F 1108	-	59,75	38	66,0	GG	5F	16,29 €
	26 8M30 5F 1108	-	64,84	38	71,0	GG	5F	17,04 €
	28 8M30 5F 1210	-	70,08	38	75,0	ST	5F	17,64 €
	30 8M30 3F 1615	-	75,13	38	83,0	ST	3F	18,07 €
	32 8M30 3F 1615	-	80,16	38	87,0	GG	3F	18,51 €
	34 8M30 3F 1615	-	85,22	38	91,0	GG	3F	19,56 €
	36 8M30 3F 1615	-	90,30	38	98,5	GG	3F	20,28 €
	38 8M30 3F 1615	-	95,39	38	103,0	GG	3F	22,05 €
	40 8M30 3F 1615	-	100,49	38	106,0	GG	3F	23,24 €
	44 8M30 4F 2012	-	110,67	38	119,0	GG	4F	26,65 €
	48 8M30 4F 2012	-	120,86	38	127,0	GG	4F	29,77 €
	56 8M30 4F 2012	-	141,23	38	148,0	GG	4F	36,74 €
	64 8M30 8F 2517	125	161,60	38	168,0	GG	8F	43,82 €
	72 8M30 8WF 2517	125	181,97	38	192,0	GG	8WF	53,45 €
	80 8M30 8W 2517	125	202,35	38	-	GG	8W	59,37 €
	90 8M30 8A 2517	125	227,81	38	-	GG	8A	67,95 €
	112 8M30 8A 2517	125	283,83	38	-	GG	8A	82,33 €
144 8M30 8A 2517	125	365,69	38	-	GG	8A	108,98 €	

Lagerprogramm 14M TL

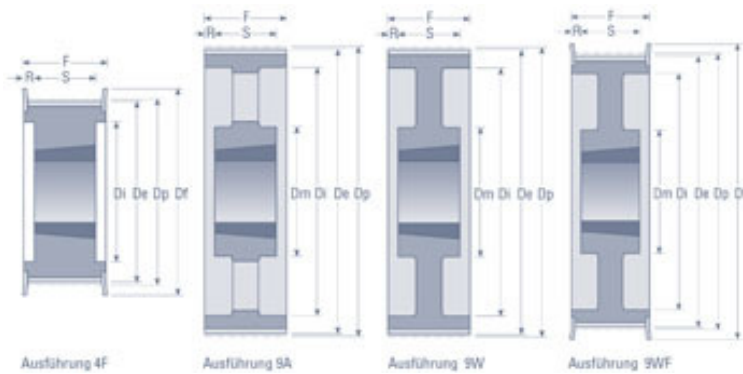

Bestellbezeichnung	d (mm)	dK	Verzahnte Breite B	dB	Werkstoff	Type	EUR/€ Stück
--------------------	--------	----	--------------------	----	-----------	------	-------------

14M Riemenbreite b=40 mm	28 14M 40 4F 2012	-	122,12	54	127	GG	4F	47,23 €
	29 14M 40 4F 2012	-	126,57	54	138	GG	4F	48,42 €
	30 14M 40 4F 2012	-	130,99	54	138	GG	4F	51,82 €
	32 14M 40 4F 2012	-	139,88	54	154	GG	4F	54,78 €
	34 14M 40 4F 2517	-	148,79	54	160	GG	4F	57,90 €
	36 14M 40 4F 2517	-	157,68	54	168	GG	4F	64,11 €
	38 14M 40 4F 2517	-	166,60	54	183	GG	4F	67,09 €
	40 14M 40 4F 2517	-	175,49	54	188	GG	4F	72,40 €
	44 14M 40 4F 3020	-	193,28	54	211	GG	4F	78,49 €
	48 14M 40 4F 3020	-	211,11	54	226	GG	4F	96,99 €
	56 14M 40 9WF 3020	170	246,79	54	256	GG	9WF	109,14 €
	64 14M 40 9WF 3020	170	282,41	54	296	GG	9WF	114,60 €
	72 14M 40 9W 3020	170	318,06	54	-	GG	9W	137,27 €
	80 14M 40 9A 3020	170	353,71	54	-	GG	9A	152,50 €
	90 14M 40 9A 3020	170	398,28	54	-	GG	9A	183,01 €
	112 14M 40 9A 3020	170	496,32	54	-	GG	9A	221,08 €
	144 14M 40 9A 3020	170	638,92	54	-	GG	9A	335,39 €
	168 14M 40 9A 3020	170	745,87	54	-	GG	9A	358,33 €
	192 14M 40 9A 3020	170	852,82	54	-	GG	9A	439,03 €
216 14M 40 9A 3020	170	959,76	54	-	GG	9A	559,27 €	

14M Riemenbreite b=55 mm	28 14M 55 4F 2012	-	122,12	70	127	GG	4F	53,45 €
	29 14M 55 4F 2012	-	126,57	70	138	GG	4F	54,64 €
	30 14M 55 4F 2517	-	130,99	70	138	GG	4F	57,90 €
	32 14M 55 4F 2517	-	139,88	70	154	GG	4F	65,60 €
	34 14M 55 4F 2517	-	148,79	70	160	GG	4F	71,66 €
	36 14M 55 4F 2517	-	157,68	70	168	GG	4F	76,25 €
	38 14M 55 4F 2517	-	166,60	70	183	GG	4F	80,84 €
	40 14M 55 4F 2517	-	175,49	70	188	GG	4F	85,29 €
	44 14M 55 4F 3020	-	193,28	70	211	GG	4F	96,11 €
	48 14M 55 4F 3020	-	211,11	70	226	GG	4F	109,86 €
	56 14M 55 9WF 3020	170	246,76	70	256	GG	9WF	131,05 €
	64 14M 55 9WF 3020	170	282,41	70	296	GG	9WF	143,34 €
	72 14M 55 9W 3020	170	318,06	70	-	GG	9W	155,48 €
	80 14M 55 9A 3020	170	353,71	70	-	GG	9A	167,77 €
	90 14M 55 9A 3020	170	398,28	70	-	GG	9A	190,71 €
	112 14M 55 9A 3020	170	496,32	70	-	GG	9A	243,88 €
	144 14M 55 9A 3020	170	638,92	70	-	GG	9A	353,74 €
	168 14M 55 9A 3020	170	745,87	70	-	GG	9A	457,40 €
	192 14M 55 9A 3020	170	852,82	70	-	GG	9A	526,10 €
	216 14M 55 7A 3535	190	959,76	70	-	GG	7A	665,12 €
238 14M 55T 3535	190	1057,81	70	-	GG	7A	1.068,27 €	

Lagerprogramm 14M TL

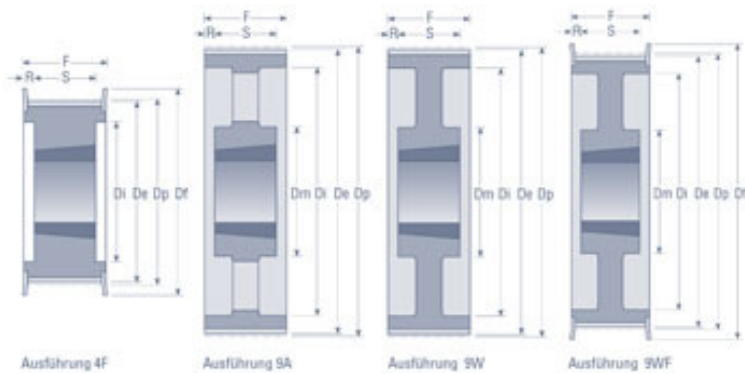

Bestellbezeichnung	d (mm)	dK	Verzahnte Breite B	dB	Werkstoff	Type	EUR/€ Stück
--------------------	--------	----	--------------------	----	-----------	------	-------------

14M Riemenbreite b=85 mm	28 14M85 4F 2517	-	122,12	98	127	GG	4F	67,09 €
	29 14M85 4F 2517	-	126,57	100	138	GG	4F	69,14 €
	30 14M85 4F 2517	-	130,99	100	138	GG	4F	73,15 €
	32 14M85 4F 2517	-	139,88	108	154	GG	4F	80,84 €
	34 14M85 4F 2517	-	148,79	110	160	GG	4F	91,52 €
	36 14M85 4F 3020	-	157,68	125	168	GG	4F	96,11 €
	38 14M85 4F 3020	-	166,60	130	183	GG	4F	99,21 €
	40 14M85 4F 3020	-	175,49	138	188	GG	4F	106,76 €
	44 14M85 4F 3030	-	193,28	155	211	GG	4F	126,60 €
	48 14M85 4F 3030	-	211,11	170	226	GG	4F	137,27 €
	56 14M85 4F 3525	190	246,76	210	256	GG	4F	167,77 €
	64 14M85 9WF 3525	190	282,41	242	296	GG	9WF	183,01 €
	72 14M85 9W 3525	190	318,06	280	-	GG	9W	198,12 €
	80 14M85 9A 3525	190	353,71	315	-	GG	9A	207,30 €
	90 14M85 9A 3525	190	398,28	360	-	GG	9A	248,61 €
	112 14M85 9A 3525	190	496,32	457	-	GG	9A	335,39 €
	144 14M85 9A 3525	190	638,92	600	-	GG	9A	426,89 €
	168 14M85 9A 3525	190	745,87	706	-	GG	9A	533,65 €
	192 14M85 3A 4040	230	852,82	813	-	GG	3A	647,96 €
216 14M85 3A 4040	230	959,76	920	-	GG	3A	826,38 €	